

Varenummer: 204380M24150D0T
 Beskrivelse: E+G Justerfod
 GN 43-80-M24-150-D0-T
 Note: T Uden møtrik, spændeflade i bunden

Mål

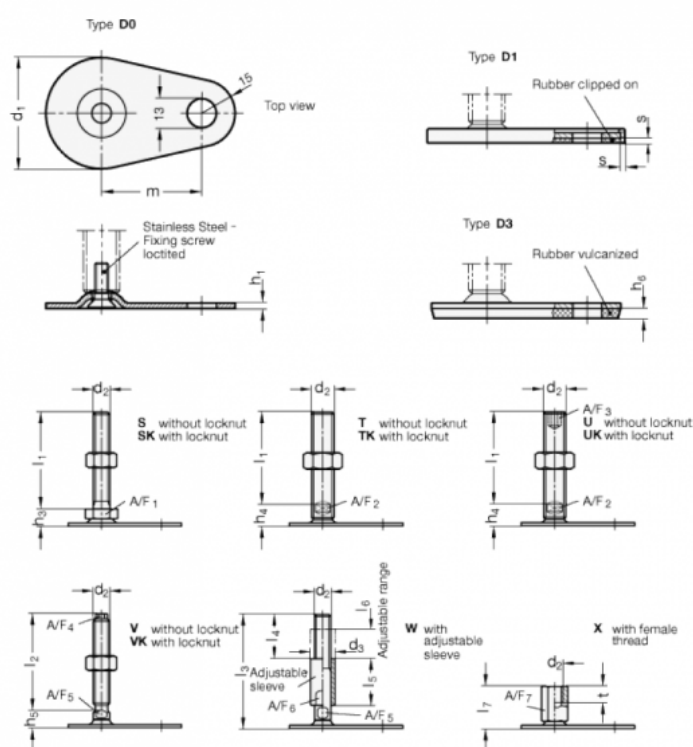

A/F2 = 19

s =

d1 = 80

d2 = M24

h1 = 3

h4 = 21

h6 =

l1 = 150

m = 70